

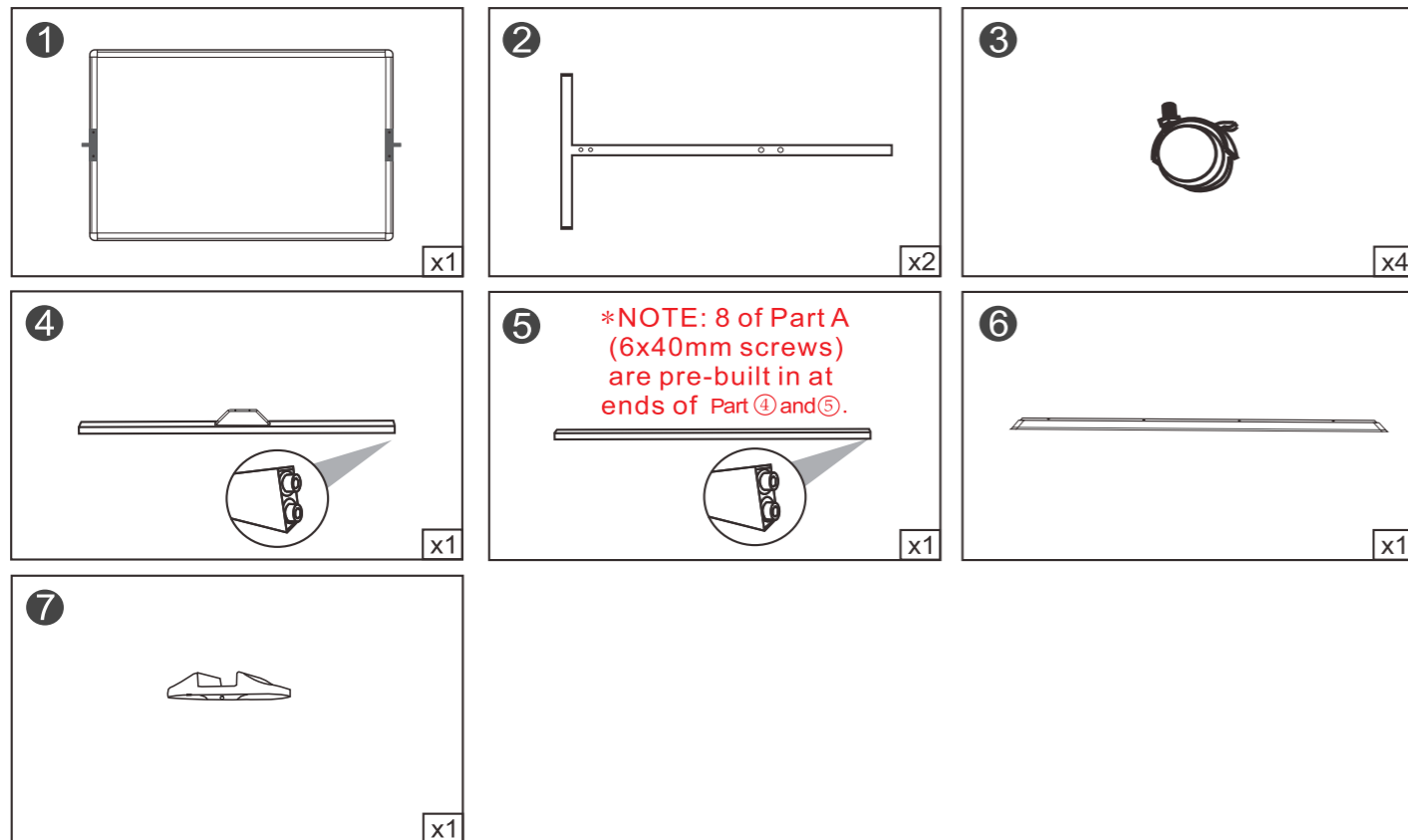







Before Assembly

When you unpack and prepare for assembly, please place the contents on a carpeted or padded area to protect them from damage

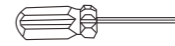

Part	Qty	Name	Refer Picture	Part	Qty	Name	Refer Picture
A	8	6x40mm Screw	 Note: The screws are pre-installed in both ends of the metal bars.	E	1	wrench	
B	4	4x10mm Screw (Big head)		F	2	Plastic Mat	
C	1	Screwdriver		G	2	4x10mm Screw (Small head)	
D	1	Spanner		H	Several	Spare Parts	

Tips for using the whiteboard

1. Each whiteboard is covered with a plastic protective film that aims to protect the surface of the product. Please make sure that you have peeled it off before using.
2. For the pens, it is recommended to use a water-based pen for all our whiteboards because of the special material of board (Please don't use oil-based pens).
3. For the board surface, if the board looks dirty, please wipe it with a damp cloth or wet tissue, or you can use the whiteboard cleaner/lightly-dampened alcohol, so the board can be used just as new after drying.
4. Before using, check the board surface if it's clean, no dirt, no water stains or no alcohol residue on it.

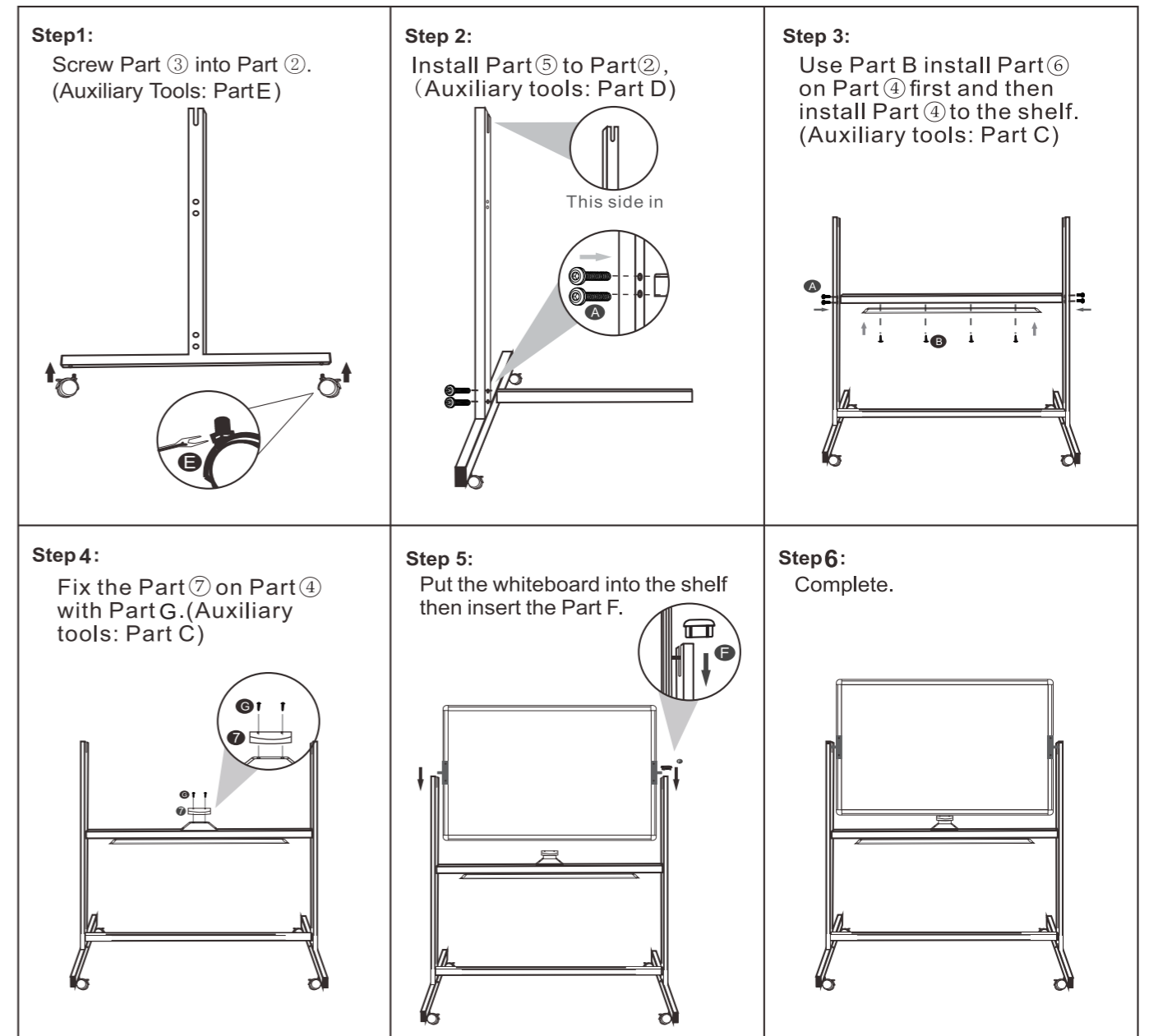

A blue oval graphic with a white border, containing the text 'Mobile Whiteboard User Manual'.

**Mobile Whiteboard
User Manual**